

Article number: 433000110

Description: Rota-fix shaft-hub connection C 110x124

Note: Not self centering. Small radial dimensions

Measures

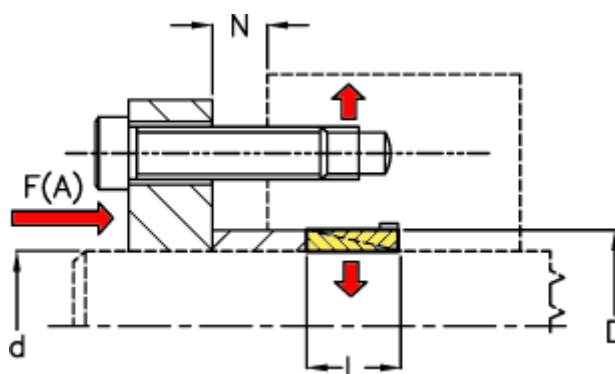

d mm = 110

D mm = 124

$F(A)$ kN = 450

Fit tolerance = Aksel \varnothing ? 38 h6, Aksel \varnothing > 38 h8, Nav \varnothing ? 38 H7, Nav > \varnothing 38 H8

F kN torque = 86.0

L = 21

$N1$ = 5

$N2$ = 6

$N3$

$N4$

P N/mm² surface press

Surface roughness

T N m torque